



Owner's Manual



Table of Contents

Important Hot Tub Owner Safety Information.....	1
Installation.....	6
Inspection and Shipping Claim.....	6
Positioning Your Hot Tub.....	6
Electrical Requirements.....	9
Electrical Precautions.....	9
Outdoor Installation.....	11
Indoor Installation.....	11
Drainage.....	11
Electrical Conversion from 50AMP to 30AMP Operation.....	12
Alexa Electrical Conversion.....	13
Optional Ozone Generator Installation Instructions.....	14
Preparing the Hot Tub for Filling.....	16
Operation.....	18
Operating Instructions.....	18
Alexa with 120VAC, 20AMP GFCI Line Cord.....	19
Control Panel.....	20
Automatic Filter Cycles.....	21
Display Messages.....	22
Alexa Control Panel.....	23
Filter Cycles.....	24
Overheat Protection.....	24
Flow Switch Detection.....	24
Open Sensor.....	24
Normal Operation/Whirlpool System.....	25
Silent Air Induction.....	26
Water Rainbow.....	27
Maintenance.....	28
Water Quality and Water Chemistry.....	28
Filtration.....	29
Water Chemistry.....	30
Disinfecting.....	30
Balancing pH.....	31
Balancing Total Alkalinity.....	31
Water Quality Definitions.....	32
Water Level/Drain.....	33
Skimmer Basket Maintenance.....	34
Filter Maintenance.....	34
Factory Installed Wood Skirt.....	35
Automatic Filtration/Maintenance.....	35
Winterizing.....	36

Hot Tub Light.....	37
Cleaning Your Hot Tub.....	38
Covering Your Hot Tub.....	38
Repairs to the Acrylic.....	39
Headrest Pillows.....	39
Troubleshooting.....	40
Alternate Use of the Water Rainbow as a Fill Spout.....	43

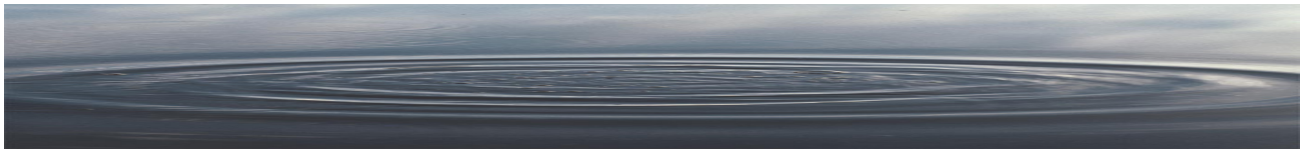

Important Hot Tub Owner Safety Information

Read and Follow ALL Instructions

Your Jacuzzi Premium spa is constructed to the highest standards and is capable of providing many years of trouble-free use. However, because heat retentive materials are utilized to insulate the hot tub for efficient operation, an uncovered hot tub surface directly exposed to sunlight and high temperatures for an extended period is subject to permanent damage. Damage caused by exposing the hot tub to this abuse is not covered by warranty. We recommend that you always keep the hot tub full of water when it is exposed to direct sunlight and that you keep the Jacuzzi Premium Spas insulating cover in place at all times when the hot tub is not in use. Read and carefully follow the requirements for your hot tub's support base (found in the section titled, " Locating Your Jacuzzi Premium spa").

Jacuzzi Premium Spas constantly strives to offer the finest hot tubs available, therefore modifications and enhancements may be made which affect the specifications, illustrations and/or instructions contained herein.

FCC Notice

This equipment has been tested and found to comply with the limits for a Class B Digital Device, pursuant to Part 15 of the FCC Rules. These limits are designed to provide reasonable protection against harmful interference in a residential installation. This equipment generates, uses and can radiate radio frequency energy and, if not installed and used in accordance with the instructions, may cause harmful interference to radio communications. However, there is no guarantee that interference will not occur in a particular installation. If this equipment does cause harmful interference to radio or television reception, which can be determined by turning the equipment off and on, the user is encouraged to try to correct the interference by one or more of the following measures: 1) Rearrange or relocate the receiving antenna. 2) Increase the separation between the equipment and receiver. 3) Connect the equipment into an outlet on a circuit different from the circuit connected. 4) Consult the dealer or an experienced radio/TV technician for help. (Changes or modifications not expressly approved by the party responsible for FCC compliance could void the user's authority to operate this equipment.)

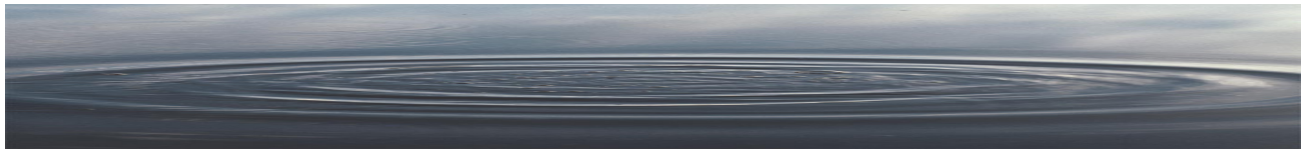

Important Hot Tub Owner Safety Information

Read and Follow ALL Instructions

Warning-Risk of injury: Children, the elderly, and the infirm should not use the hot tub unless they are supervised at all times. Infants should not be permitted in the hot tub at water temperatures over 100°F (38°C).

Hot tub water temperature in excess of 104°F is not recommended. High water temperatures in excess of 104°F (40°C) and prolonged periods of use can raise internal body temperature excessively and impair the body's ability to regulate its internal temperature.

Pregnant women and people with heart circulatory conditions, or diabetes, should consult their physicians before using the hot tub at water temperatures over 100°F (38°C).

Limit your initial use of the hot tub to 10-15 minutes. High body temperatures affect people differently; consult your physician about your safety and comfort before using the hot tub.

If your hot tub product does not have a thermometer, we recommend that you use a medical (clinical) type of thermometer for an accurate measurement of hot tub water temperatures. Other types of thermometers, generally available, such as those used for swimming pools are not sufficiently accurate to determine hot tub water temperature.

Extra care should be taken when using the hot tub and consuming alcoholic beverages. Alcohol, drugs, or certain medications, such as tranquilizers, affect a person's ability to withstand high temperatures and may produce dangerous effects, including drowning. Persons using medication should consult with a physician before using a hot tub. The use of alcohol or drugs can greatly increase the risk of fatal hyperthermia in hot tubs.

Hyperthermia

Prolonged immersion in hot water may induce hyperthermia. A description of the causes, symptoms, and effects of hyperthermia are as follows: Hyperthermia occurs when the internal temperature of the body reaches a level several degrees above the normal body temperature of 98.6°F (37°C). The symptoms of hyperthermia include drowsiness, lethargy, and an increase in the internal temperature of the body. The effects of hyperthermia include: 1) Unawareness of impending hazard; 2) Failure to perceive heat; 3) Failure to recognize the need to exit the hot tub; 4) Physical inability to exit the hot tub; 5) Fetal damage in pregnant women; and 6) Unconsciousness and danger of drowning.

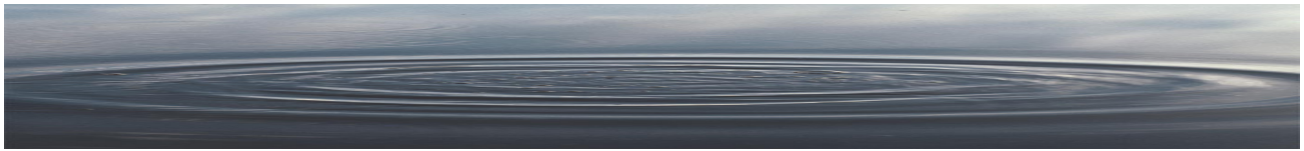

Important Hot Tub Owner Safety Information

Read and Follow ALL Instructions

Danger-Risk of injury: Do not remove the suction grille! It is a safety device and must always be in place on the suction fitting to minimize the potential hazard of hair entanglement or body entrapment.

Keep body, hair, and clothing a minimum of 12 inches away from suction fitting and skimmers at all times when the hot tub is operating. Hair longer than shoulder length should be secured close to the head, or a bathing cap should be worn.

Do not operate the hot tub if the suction cover is broken or missing. Contact your Dealer for replacement cover if broken or missing.

The wet surface of the hot tub is slippery. Use care when entering or exiting.

Danger-Risk of child drowning: Do not permit children to use this product unless they are closely supervised. The use of a locked cover is highly recommended to prevent unattended access.

DANGER-RISK OF ELECTRICAL SHOCK: When installing and operating this electrical equipment, basic safety precautions should always be adhered to.

Warning: A wire connector is provided at the electrical cabinet on this hot tub to connect a minimum No. 8 AWG (8.4mm) solid copper conductor between this hot tub and any metal equipment, metal enclosures of electrical equipment, metal water pipe, or conduit within 5 feet (1.5m) of the hot tub.

Do not use electrically connected devices such as televisions, radios, or stereo speakers, lights, cooking devices, or telephones within 5 feet (1.5m) of the hot tub while the hot tub is being used. Lighting fixtures must not be located directly above or within 5 feet (1.5m) of the hot tub. If located within 10 feet (3.0m) of the hot tub, they must be on a circuit protected by a GFCI (Ground Fault Circuit Interrupter).

All fixed metal objects located within 5 feet (1.5m) of the hot tub, such as fence posts, railings, door frames, greenhouse structures, gutters, etc., must be attached to the bonding bar on the outside of the hot tub electrical cabinet using #8 solid copper wire. **With #8 solid copper wire, bond the hot tub to the house electrical panel or approved local bond.**

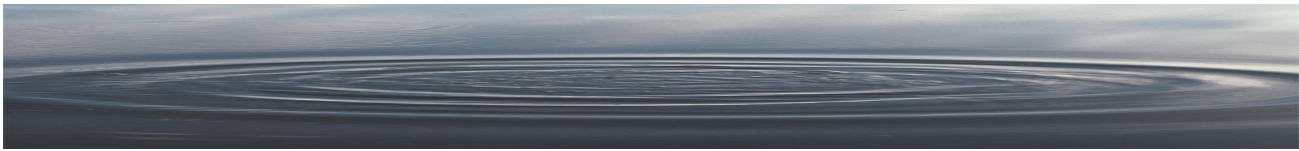

Important Hot Tub Owner Safety Information

Read and Follow ALL Instructions

The spa must be installed with adequate access and water drainage system (refer to Installation), to drain water away from electrical components.

CAUTION: Do not turn power ON to the hot tub unless it is filled with water to the normal water level, which is to the water level indicator mark on the skimmer frame. Activating the hot tub when there is an insufficient amount of water can damage the circulation pump and may cause a fire.

Hot tubs installed in a 230VAC circuit:

DANGER-RISK OF ELECTRICAL SHOCK

Your hot tub must be equipped with a GFCI at the Main Electrical Panel. At initial start-up and before each use thereafter with power ON, push the GFCI test button. The reset button should pop out. Push this button in to reset. If the interrupter fails to operate in this manner, there is a ground current flowing or a device malfunctioning, indicating the possibility of electrical shock.

Turn off power and do not use the hot tub until the source of the breakdown has been identified and corrected.

Read manufacturer's safety information provided with all optional equipment.

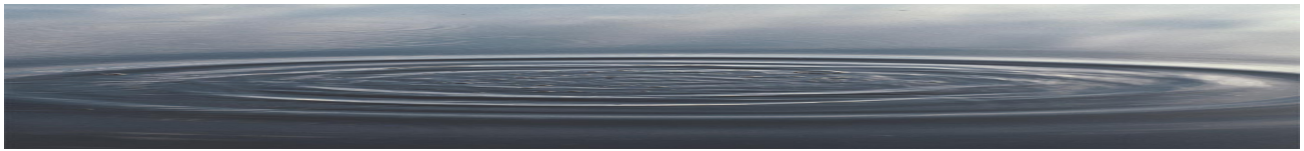

Important Hot Tub Owner Safety Information

Read and Follow ALL Instructions

If your hot tub is installed in a 120VAC, 20AMP circuit:

1. The hot tub is supplied with a 15 foot line cord which terminates with an integral GFCI plug. Locate the hot tub near enough to a weather protected outlet, but no closer than 10 feet. **DO NOT USE AN EXTENSION CORD!** Using an extension cord is hazardous and will decrease the amount of power to the unit, causing slow heating, poor whirlpool performance, or system malfunction.
2. Replace damaged line cord immediately. Do not bury the line cord. Connect to a grounded, grounding type, dedicated receptacle only.
3. Bring the line cord out from under the skirt. Remove skirt screws as required to gain access. Make sure the line cord does not lie across a walkway or in a heavily traveled area where it may be a safety hazard or become damaged.
4. At initial start-up and before each use thereafter with power ON, push the GFCI test button. The reset button should pop out. Push this button in to reset. If the interrupter fails to operate in this manner, there is a ground current flowing or a device malfunctioning, indicating the possibility of electric shock. **Turn off power and do not use the hot tub until the source of the breakdown has been identified and corrected.**

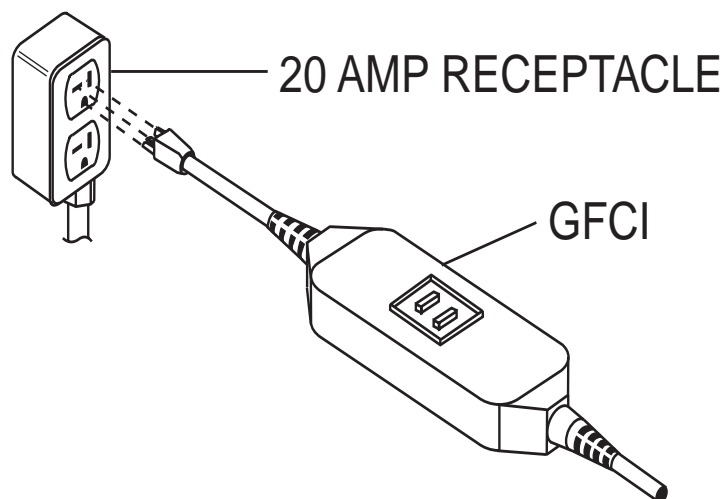

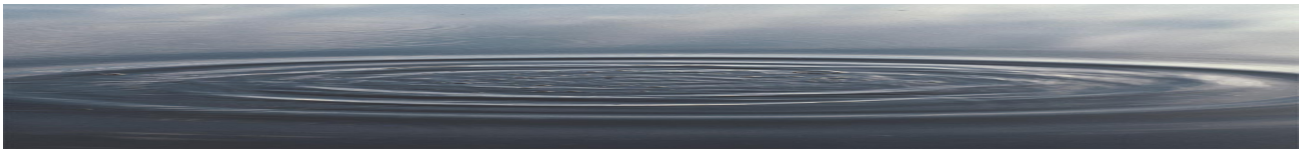

Installation

Inspection and Shipping Claim

Check for shipping damage upon receipt of the hot tub. Jacuzzi Premium Spas is not responsible for damage to the hot tub sustained during shipment. If damage is evident before unpacking, refer to instructions regarding shipping claims on the outside of the carton and immediately file a claim with the carrier.

Once the hot tub has been removed from the carton and before it is permanently installed, check the hot tub completely for damage. Fill the shell with water and operate the system (refer to Operating Instructions) to check for leaks which may have resulted from improper shipping or handling. All Jacuzzi Premium Spas hot tubs are factory tested for proper operation and water tight connections prior to shipment. If leaks or other problems are detected, immediately notify your Jacuzzi Premium Spas hot tub dealer or Authorized Service Agent for Warranty Service.

NOTE: Damage or defects which could have been discovered and repaired prior to installation and which are claimed after final installation of the hot tub, are excluded from our warranty.

Positioning Your Hot Tub

IMPORTANT: Because of the combined weight of the hot tub, water and users, it is extremely important that the base upon which the hot tub rests be smooth, flat, level and capable of uniformly supporting this weight, without shifting or settling, for the entire time the hot tub is in place. If the hot tub is placed on a surface which does not meet these requirements, damage to the skirt and/or the hot tub shell may result. Damage caused by improper support is not covered under warranty. It is the responsibility of the hot tub owner to assure the integrity of the support over time.

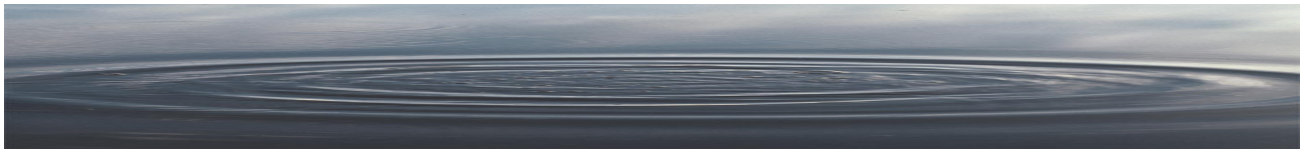

Installation

Wood decking is acceptable provided it is constructed so that it meets the requirements outlined on the previous page. However, we recommend a poured, reinforced concrete slab (minimum 4 inches thick) as shown below.

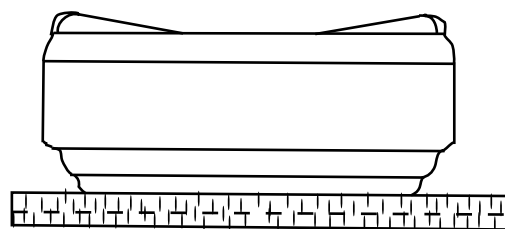
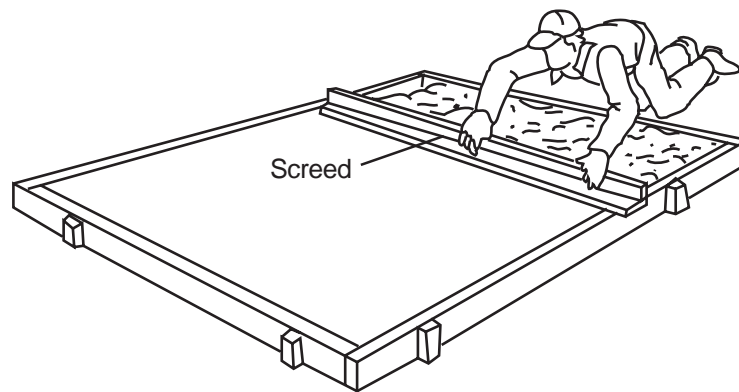

Start with the forms built from 2X4's and 1X2 stakes as shown above. The foundation must be as large as the bottom of the hot tub. Dig down 2 inches below the bottom of the forms and fill back to the bottom of the forms with clean sand. It is recommended that you lay a 1-foot-square grid of 1/2" reinforcing rods over the level sand bed, tying them together with bailing wire. Mix concrete and pour it into the form, spreading it evenly with a sturdy steel rake. Level concrete with a screed built from 1X4's as shown above. Pull the screed toward you with a side-topside zigzag motion. When concrete is leveled, smooth out with a large mason's float. Allow concrete to cure at least one week before setting tub.

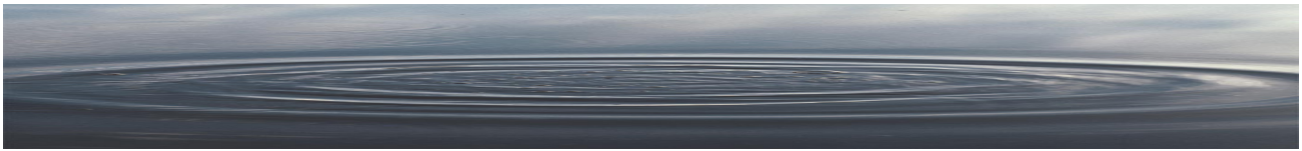

Installation

The hot tub must be installed in such a manner as to provide drainage away from the hot tub. Placing the hot tub in a depression without provisions for proper drainage could allow rain, overflow and other casual water to flood the equipment and create a wet condition in which it would sit.

For hot tubs which will be recessed into a floor or deck, install so as to permit access to the equipment, either from above or below, for servicing. Make certain that there are no obstructions which would prevent removal of the cabinet side panels, especially on the side with the equipment bay doors.

In selecting the ideal *outdoor* location for your hot tub, we suggest that you take into consideration 1) the proximity to change area and shelter (especially in colder weather); 2) the pathway to and from your hot tub (this should be free of debris so that dirt and leaves are not easily tracked into the hot tub); 3) the closeness to trees and shrubbery (remember that leaves and birds could create extra work in keeping the hot tub clean); 4) a sheltered environment (less wind and weather exposure can result in lowered operation and maintenance costs); and 5) the overall enhancement of your environment. It is preferable *not* to place the hot tub under an unguttered roof overhang since run-off water will shorten the life expectancy of the hot tub cover.

For *indoor* installations, be certain to make provisions for proper ventilation. When the hot tub is in use, considerable amounts of moisture will escape. This can damage certain surfaces over time.

If you have any questions regarding the placement or installation of your hot tub, consult your authorized Jacuzzi Premium Spas Dealer.

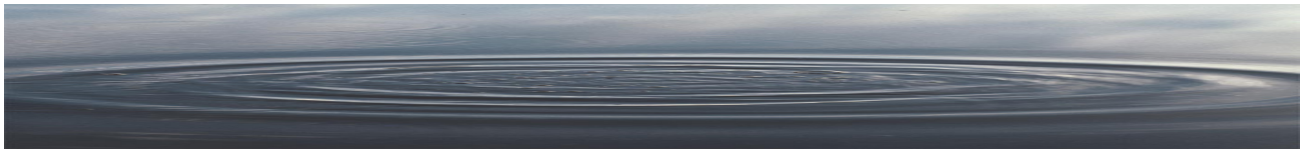

Installation

Electrical Requirements

Your Jacuzzi Premium Spas hot tub (except the Triton) requires a 230VAC, 50 AMP, 4-wire grounded type GFCI protected electrical service with copper conductors, and must be in a separate circuit having no other appliance connected in that circuit. If you do not have this kind of circuit, a *qualified* electrician should install the necessary wiring. A wiring diagram is provided on the inside cover of the electrical control box. Inadequately sized wiring may cause the unit to malfunction and bring about permanent damage to the hot tub's electrical system. The circuit must also have a ground wire in order to take advantage of the designed-in safety features of the hot tub. A bond wire must also be used. Bond according to procedure described below.

WARNING: Without proper grounding and bonding, a system malfunction may cause fatal shock.

Electrical Precautions

CAUTION: Do NOT apply electrical power to the hot tub unless it is filled with water to the normal water level, which is approximately 7" below the hot tub rim (refer to location of water level indicator on the face of skimmer). If the hot tub's motor/pump(s) are actuated when there is not sufficient water in the unit, the circulation pump could be irreparably damaged. Not heeding this caution will nullify the warranty. In addition to damaging the unit, operating the unit with insufficient water could cause a fire.

Do NOT locate lighting fixtures directly above the hot tub; lighting and electrical receptacles must be located at least 5 feet from the hot tub. Lighting located between 5 and 10 feet from the hot tub must be on a circuit protected by a GFCI. (Refer to National Electrical Code, 680-6.)

Do NOT use electrically connected devices, such as televisions, radio, telephones, stereo speakers, light or cooking devices within 5 feet of the hot tub when the hot tub is being used.

All fixed metal objects located within 5 feet of the hot tub, such as fence posts, railings, door frames, greenhouse structures, gutters, etc., must be attached to the bonding bar on the outside of the hot tub electrical cabinet using #8 solid copper wire. **With #8 solid copper wire, bond the hot tub to the house electrical panel or approved local bond.**

An approved ground may be an 8 foot long ground rod, a plate electrode, or a buried metal water pipe with at least 10 feet of buried pipe. Check your local building code for requirements. Bonding lugs are available at your local electrical supply store. (Bond bar location is shown on the next page.)

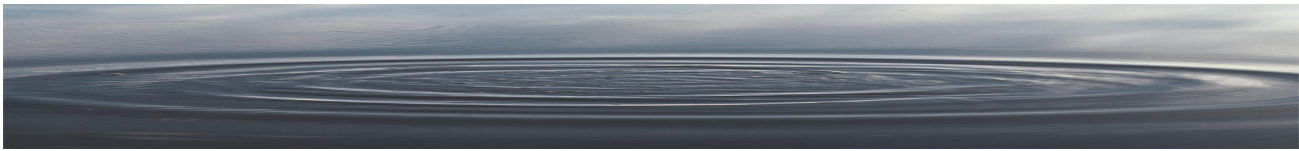

Installation

Equipment Area

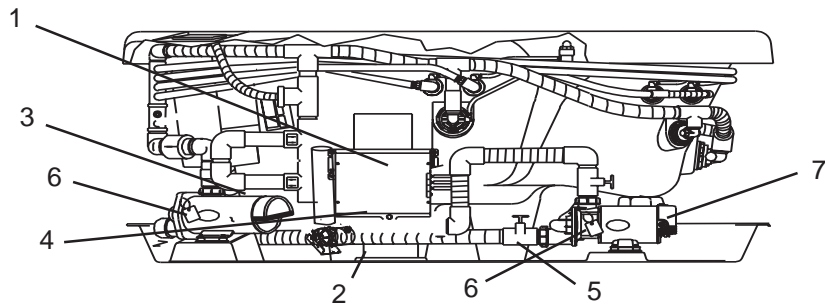

- | | |
|--------------------------|---------------------|
| 1. Electrical Cabinet | 5. Hot Tub Drain |
| 2. Power Supply Entrance | 6. Pump Drain Plugs |
| 3. Pump | 7. Pump #2 |
| 4. Heater | |

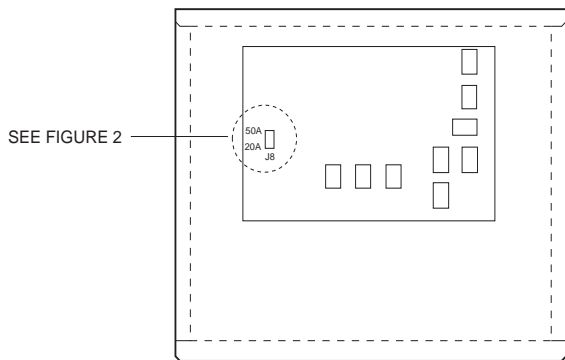

FIGURE 1

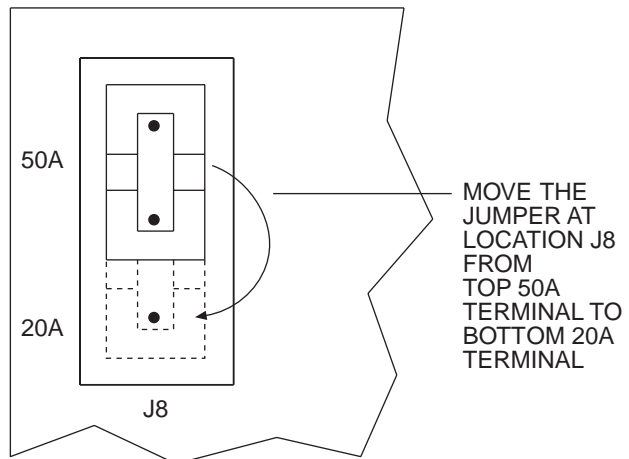

FIGURE 2

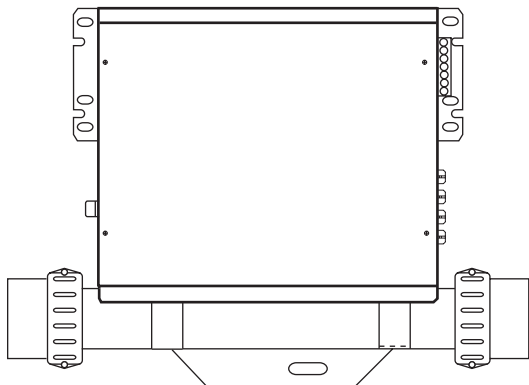
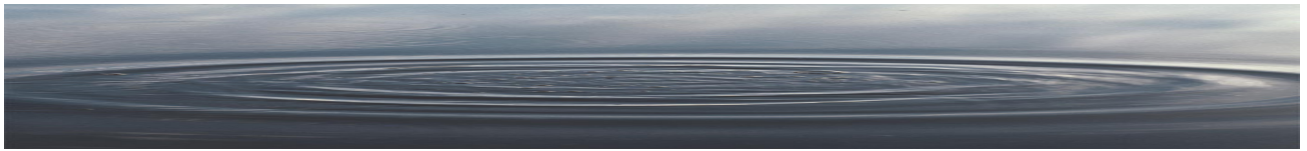

FIGURE 3



Installation

Outdoor Installation

If you install the hot tub outdoors, we recommend that you provide a concrete pad for it to rest on. To do this, see instructions for constructing a concrete pad on page 6.

Indoor Installation

Water that splashes on the floor during hot tub use may cause a walking hazard and/or structural damage. Good drainage must be provided and proper waterproof building materials must be used in the area surrounding and beneath the hot tub. Take into consideration that high room humidity will exist due to high spa water temperatures. Providing natural or forced ventilation of the room will help maintain comfort and minimize moisture damage to the building. Jacuzzi Premium Spas is not responsible for damages resulting from excess moisture or water spillage. Consult an architect or engineer for aid in designing your indoor installation.

Drainage

Whether you install your hot tub indoors or outdoors, you can drain it completely by attaching a garden hose to the fill and drain valve located on the pan of the hot tub. Simply run the hose to the house sewer line or drain field and open the drain valve.

Make sure the area surrounding the hot tub has good drainage to keep water from collecting at the base of the hot tub-especially near the equipment area. If drainage is poor, install a drain line and/or gravel drain field.

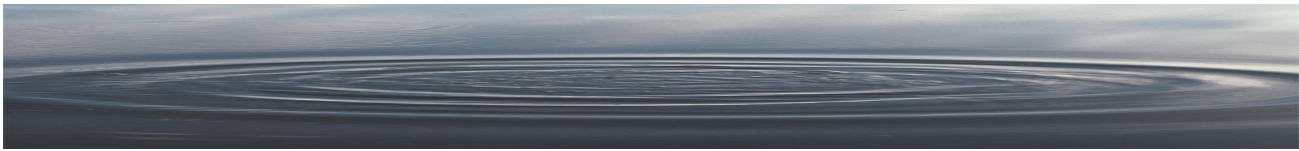

Installation

Electrical Conversion from 50AMP to 30AMP Operation (For Laser Select, Santina Select, and Aero)

Your hot tub, as it comes from the factory, requires a 240VAC, 50AMP, 4-wire, grounded type GFCI (Ground Fault Circuit Interrupter) protected electrical service. If you prefer, the hot tub can be converted to operate with a 240VAC, 30AMP electrical service. The conversion must be made by a qualified electrician. After conversion following this procedure, the hot tub heater will automatically be turned OFF whenever either the high speed jets or the air blower is activated.

To convert to 240VAC, 30AMP operation:

1. Turn OFF the breaker at the main electrical panel.
2. Open the skirt door access panel.
3. Loosen and remove the 4 screws securing the electrical cabinet cover and set them aside.
4. Move the jumper at the circuit board location J8 from the 50A position to the 20A position. Refer to Figures 1 and 2 on page 10.
5. Replace the electrical cabinet cover and tighten the screws.
6. Test for proper operation of the GFCI before using the hot tub. Refer to the installation instructions for the proper test procedure.

Alexa Electrical Conversion

The Alexa hot tub may be converted from the factory supplied 120VAC, 20AMP to operate on a 240VAC, 50AMP circuit. This must be a protected electrical service with copper conductors, a 4-wire grounded type GFCI protected circuit, and have no other appliances on the circuit. If you do not have this kind of circuit, a qualified electrician should be called in to install the necessary wiring. Inadequately sized wiring may cause a malfunction and bring about permanent damage to the hot tub's electrical system. The circuit must also have a ground wire in order to take advantage of the designed-in safety features of the hot tub. A bond wire must also be used.

CAUTION: Without proper grounding and bonding, a system malfunction may cause fatal shock.



Installation

Alexa Electrical Conversion (Continued)

This conversion will increase the heating capability of your hot tub's heater and convert the output from 1.25kW to 5.5kW (21 AMP). We recommend that this rewiring be done by a qualified electrician. A wiring diagram is provided on the inside cover of the electrical control box. When this conversion to 240VAC has been made, any combination of operating modes is possible, including having the heater on when the whirlpool mode is activated. Also, the heat-up rate will be approximately four times greater.

To convert to 240VAC, 50AMP operation:

1. Turn OFF 20AMP breaker at the main electrical panel.
2. Open the skirt door access panel.
3. Loosen and remove the four screws securing the electrical cabinet cover and set them aside.
4. Loosen screws at bottom side of terminal block and remove power cord cable clamp. Remove and discard the GFCI power cord.
5. Install 240VAC, 4-wire power cord in accordance with local code requirements. Insert the wires into the bottom side of the terminal block and tighten the screws. Refer to Figure 1.
6. Loosen the screw on the top side of the terminal block. Move the red wire from position 1 to position 4. Tighten the screws. Refer to Figure 1.
7. Move the jumper at circuit board location J8 from the 20A position to the 50A position. Refer to Figures 1 and 2.
8. Replace the electrical cabinet cover and tighten the screws. Refer to Figure 3.
9. Make sure the hot tub is filled with water to the proper level. Turn on the 50AMP GFCI breaker at the main electrical panel.
10. Test the GFCI for proper operation.

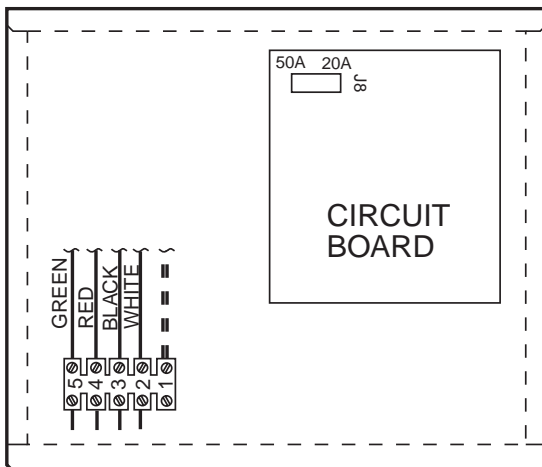

FIGURE 1

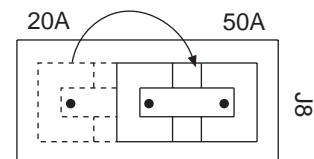

FIGURE 2

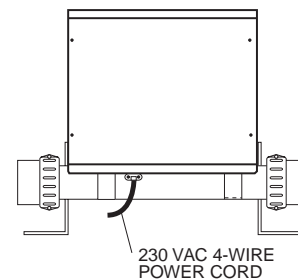
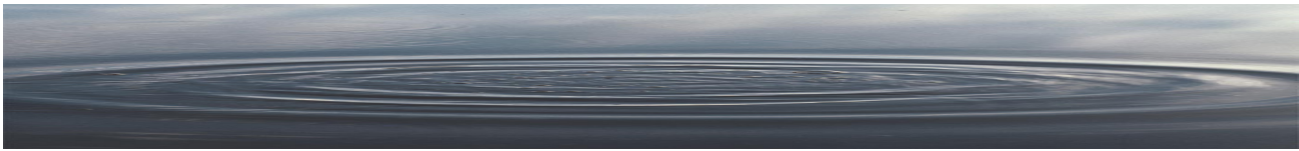

FIGURE 3



Installation

Optional Ozone Generator Installation Instructions

Your “ozone ready” hot tub is designed for easy field conversion to an ozone generator system. You will need:

- A. Complete Ozone Kit
- and
- B. Mazzei Injector

Instructions:

1. Turn OFF electrical power and drain the hot tub.
2. Temporarily remove the equipment access skirt panel and other skirt panels as required for access to the plumbing.
3. Cut off and discard the PVC caps at the end of each length of flexible vinyl tubing as shown in Figure 1.

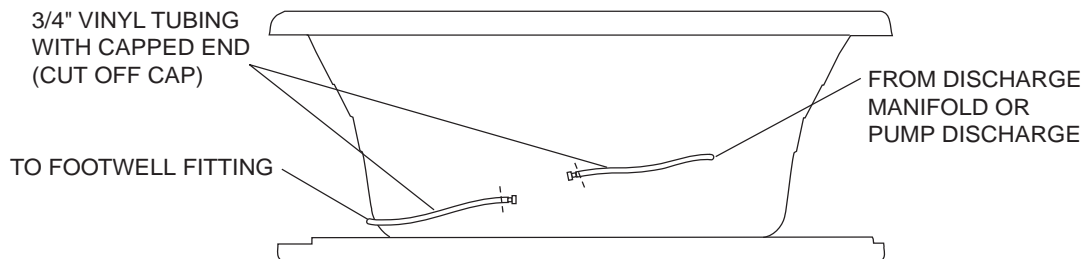
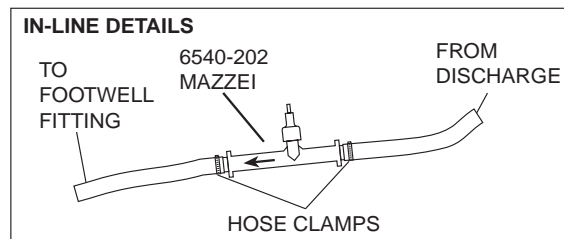

FIGURE 1 - "OZONE-READY" SPA BEFORE CONVERSION (SKIRTS REMOVED)

(Some items not shown for clarity)

4. Insert Injector fitting into flexible vinyl tubing and secure with hose clamps (2). Do **NOT** change the length of the flexible vinyl tubing downstream of the red ozone injector. Observe the “proper orientation” of the red ozone injector; make sure the molded-in arrow points downstream to the footwell fitting. See Figure 2.



(NOTE: Flow arrow on injector points downstream to footwell.)

FIGURE 2 - OZONE INJECTOR LINE CONVERSION

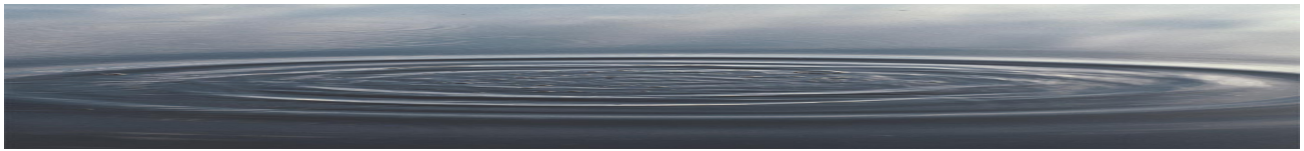

Installation

5. Install the ozone generator according to the manufacturer's instructions. Several commercially available ozone generators will fit easily.

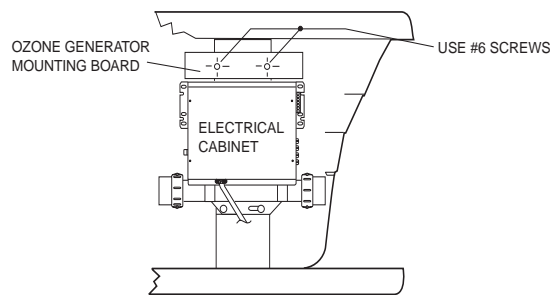

FIGURE 3 - MOUNTING BOARD

6. Attach the ozone delivery tubing (supplied with the ozone generator) between the ozone generator outlet port and the ozone injector inlet. Form the extra length of tubing into two or more loops 6"-12" in diameter. Find the bonded clip underneath the hot tub rim near the control panel area and secure the loops in a maximum height position by attaching the loops with a tie wrap strap to this clip.

NOTE: If the ozone generator or ozone tubing includes a check valve, make certain it is correctly oriented and correctly functioning before installation. The check valve should permit ozone gas flow **from** the ozone generator **to** the ozone injector. See Figure 4.

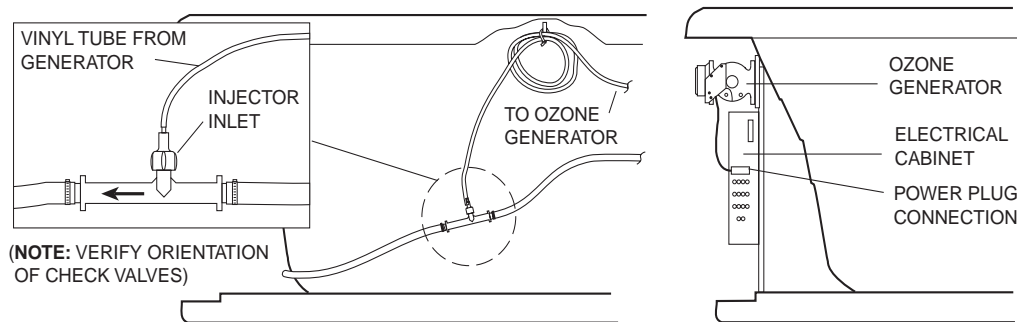
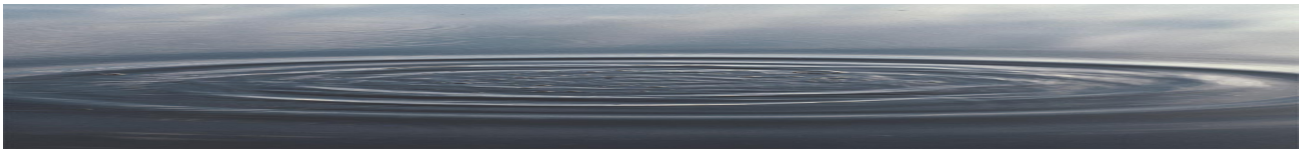

FIGURE 4 - OZONE GENERATOR VINYL TUBING

7. Refill the hot tub with water to the fill mark on the skimmer frame. Check for leaks.
8. Plug the ozone generator power cord into the socket labeled "ozone" on the side of the hot tub electrical cabinet.
9. Turn on the circuit breaker for power to the hot tub system. Test the GFCI for proper operation.
10. Operate the hot tub and recheck for leaks.
11. Reinstall the plumbing access skirt panels and equipment access skirt panel.



Installation

Preparing the Hot Tub for Filling

1. Remove the plastic sheet covering the spa.

NOTE: Stepping into the hot tub with shoes will scratch the acrylic surface.

2. Remove any packing materials from the hot tub.

3. The filter cartridges are packaged in a plastic bag which **MUST** be removed before operating the hot tub. To gain access to the filters, pull open the skimmer/filter door by the handle located in the middle of the door and remove the skimmer basket and filter.

Front Access Skimmer/Filter

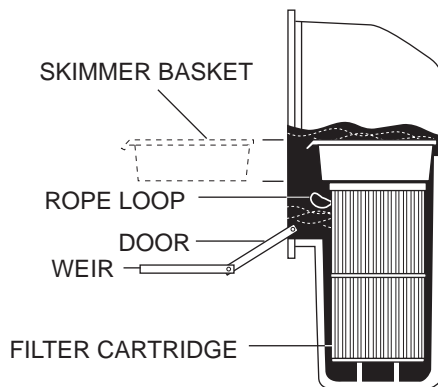

4. Clean the interior of the hot tub of any remaining construction debris. Remove stubborn stains, paint, or tar with isopropyl alcohol. A mild liquid dishwashing detergent on a damp cloth is fine for cleaning off other dirt. Plaster can be removed by scraping with a soft plastic or wooden edge. Do not use a metal scraper, wire brush, or other metal tools, as they will damage the hot tub's surface.

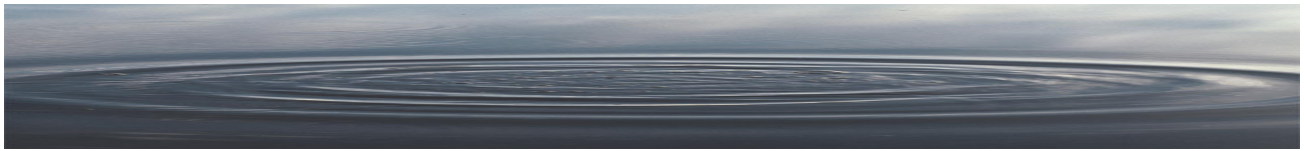

Installation

5. On initial start-up, it is recommended to purge and sanitize the system as stated below.
 - Remove the hot tub cover completely.
 - Close the drain valve on the suction plumbing.
 - Fill the hot tub with water through the filler housing to its normal level, which is to the water level indicator mark on the skimmer frame.
 - Turn ON the circuit breakers at the main electrical panel.
 - At the control panel on the hot tub rim, press the JETS button twice for maximum jet action.
 - Add 1/2 cup sodium dichlor (a fast dissolving granular type of chlorine) to the water and run for 30 minutes.
 - Turn OFF the circuit breakers.
 - **Immediately** open the drain valve and drain the hot tub completely.

CAUTION: Leave the optional cover OFF the hot tub during this procedure. DO NOT use the hot tub during this procedure. Drain the hot tub immediately afterword.
6. Close the drain valve and fill the hot tub with water (approximately 7 inches below the hot tub rim) to the water line indicator on the skimmer frame.
7. Turn ON circuit breakers at the main panel.
8. Test the hot tub for proper operation. (Refer to Operating Instructions.)
9. Add 4 tablespoons of chlorine to the water.
10. Refer to Water Quality section of the Operating Instructions. Test for water quality and then add treatment chemicals as necessary to ensure proper water quality levels.

All Jacuzzi Premium Spas hot tubs are factory tested for proper operation and water tight connections prior to shipment. If leaks or other malfunctions are detected, immediately notify your Jacuzzi Premium Spas dealer or Authorized Service Agent.

NOTE: Never fill with water from a water softener. If your water is extremely “hard”, it is preferable to fill it half way with hard water and the rest of the way with softened water. Or, you may fill entirely with hard water if you use a special water additive available from your Jacuzzi Premium Spas dealer.

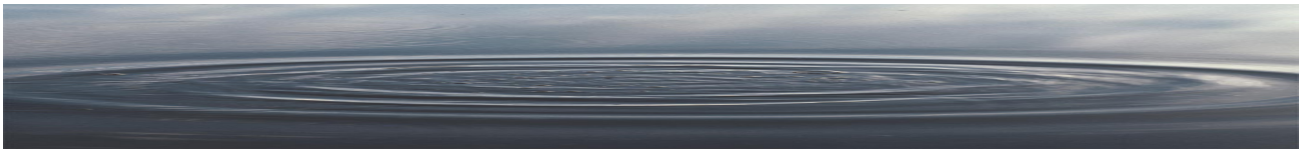

Operation

Operating Instructions

Now that the hot tub is in place, you are probably eager to take advantage of its unique designed-in features - especially the patented hydromassage performance. Besides being a beautiful addition to your indoor decor or outdoor landscaping, your Jacuzzi Premium spa will provide you with the ultimate in hot tub pleasure.

Familiarize yourself with the operation of the electronic control pad, as described on the following pages of this manual. Access under the hot tub (behind the skirts) is not required for normal operation.

WARNING: Do not turn ON power to the hot tub unless it is filled with water to the normal water level. Refer to the water line indicator mark on the skimmer frame. Whenever the power is ON, the system will activate even though no controls are operated. When there is not sufficient water in the unit with the hot tub's motor/pump actuated, the circulation pump and heater could be irreparably damaged. Not heeding this caution will nullify the warranty. In addition to damaging the unit, operating the hot tub with insufficient water could cause a fire.

Initial Instructions

Using a Garden hose, fill the hot tub with water to the water line indicator mark on the skimmer frame.

At the house service panel, turn ON the circuit breaker or switch that controls the electrical service to your hot tub. Make sure there are no other appliances on that circuit.

Hot Tub's Designed for 240VAC Circuit

Your hot tub must be installed in an electrical circuit protected with a Ground Fault Circuit Interrupter (GFCI)(refer to Electrical Requirements). At initial start-up and before each use thereafter, with power ON, push the GFCI test button. The reset button should pop out. Push this button in to reset. If the interrupter fails to operate in this manner, there is a ground current flowing or a device malfunctioning, indicating the possibility of electric shock.

DANGER: Turn OFF power and do not use the hot tub until the source of the problem has been identified and corrected.

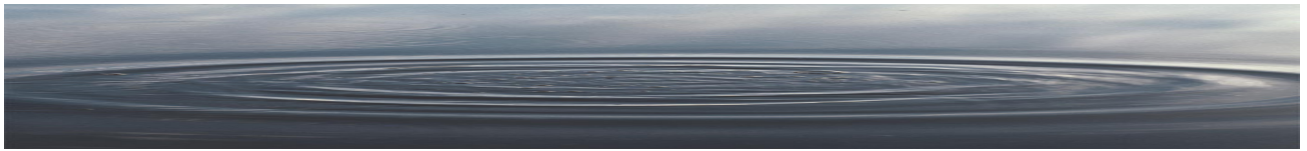

Operation

Alexa with 120VAC, 20AMP GFCI Line Cord

Your hot tub is provided with a Ground Fault Circuit Interrupter (GFCI) on the line cord. At initial start-up and before each use thereafter, with the power on, push the test button on the GFCI. The reset button should pop out. Push this button in to reset. If the interrupter fails to operate in this manner, there is a ground current flowing or a device malfunctioning, indicating the possibility of electric shock.

DANGER: Turn OFF the power and do not use the hot tub until the source of the problem has been identified and corrected.

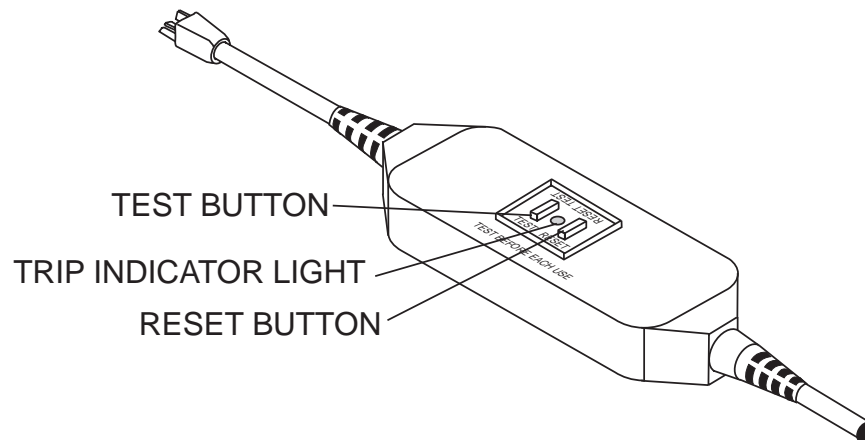

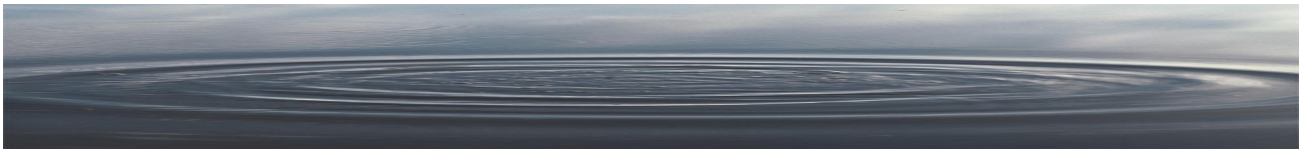

Operation

Control Panel

The hot tub will automatically begin to operate when electrical power is applied. There is no ON/OFF switch for the hot tub system. The control system has been designed so that by connecting the hot tub to its properly grounded power source, the hot tub's set temperature is preset to 100°F. Your hot tub's readout will display the water temperature, and the hot tub will heat to the set temperature. The first filter cycle will begin one minute after the hot tub is energized.

Control Panel

The control panel is easy to use with fingertip control of all of the hot tub's functions. Control of temperature, jets and hot tub light is readily accessible from within the hot tub.

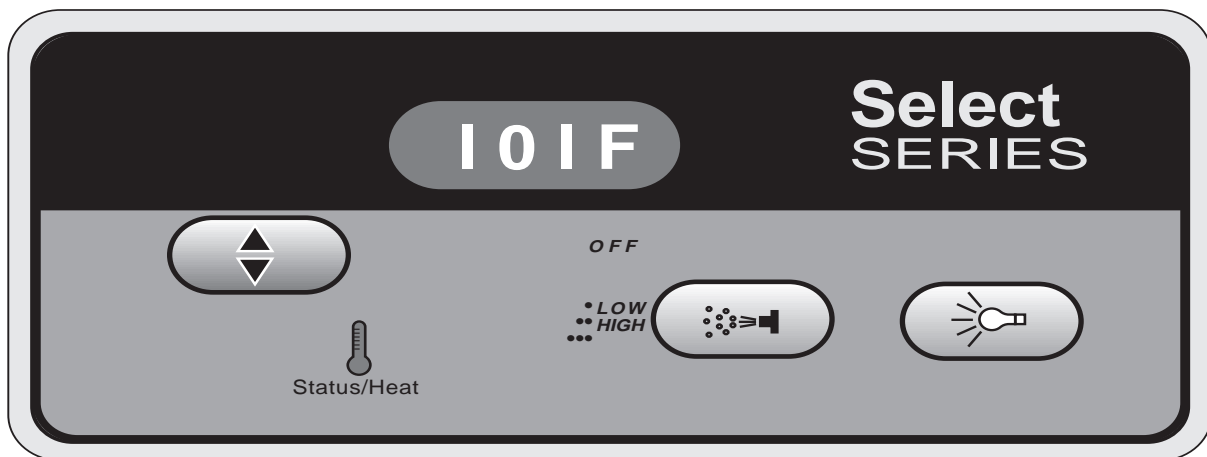

Temperature Controls

The current temperature is constantly shown on the display. After pressing the button once, the display shows the set temperature. Pressing the button a second time will cause the set temperature to increase or decrease depending on what direction was last chosen. Each successive press will change the set temperature in the same direction.

If the opposite direction is desired, release the button and let the display revert to the actual water temperature. Press the pad to display the set temperature and again to make the temperature change in the desired direction. Temperatures can be set from 80° to 104°F.



Operation

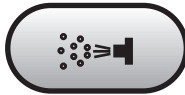

Jets Control

Press the jets button once to activate the low speed jet operation. Press the button again for the high speed jet operation, and again to deactivate the jets. The low speed jet operation will start automatically when the heater is turned on or when a filter cycle is activated. When a freeze condition is detected, high speed jets are automatically activated.

Whenever the low speed is energized with this button, it will automatically turn off after 4 hours of operation. The high speed automatically turns off after 30 minutes.



Light Control

The light button activates and deactivates the hot tub light. The hot tub light will automatically turn off after 4 hours of operation.

Automatic Filter Cycles

Your hot tub will automatically filter itself for 2 hours twice a day. The first filter cycle will begin 1 minute after the hot tub is energized. The second filter cycle will begin twelve hours after the start of the first filter cycle. The low speed jets will constantly run during the filter times (unless the high speed jets are on) and the heater will be enabled.

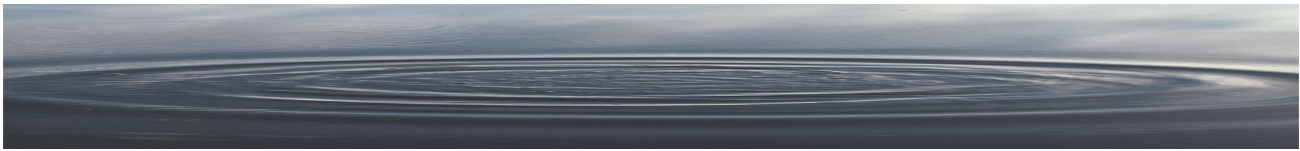

Operation

Display Messages

These are some of the messages you may see on the center display.

<u>Message</u>	<u>Meaning</u>
----------------	----------------

<i>OH</i>	Overheat Protection: The hot tub is deactivated. If a malfunction occurs and the hot tub water reaches 112°F, the system will completely shut down.
-----------	---

DANGER: DO NOT ENTER THE WATER. Turn off all power to the hot tub and contact your dealer or service organization. Press any panel button to reset.

<i>FL</i>	Flow Switch (Constantly displayed): A pressure switch has malfunctioned. Contact your dealer or service organization.
-----------	---

<i>Sn</i>	Open Sensor: Hot tub is deactivated. Either the high limit or the water temperature sensor is nonfunctional. Contact your dealer or service organization.
-----------	---



Operation

Alexa Control Panel

Initial Start Up

No programming is necessary. There is no ON/OFF switch for the system. The control system has been designed so that by connecting the hot tub to its properly grounded power source, it will begin to operate. The Status/Heat LED will light briefly. The pump will activate if the water temperature of the water is less than 65° F. The first filter cycle will start one minute after the hot tub is energized.

Control Panel

The control panel is easy to use with fingertip control of all of the hot tub functions.

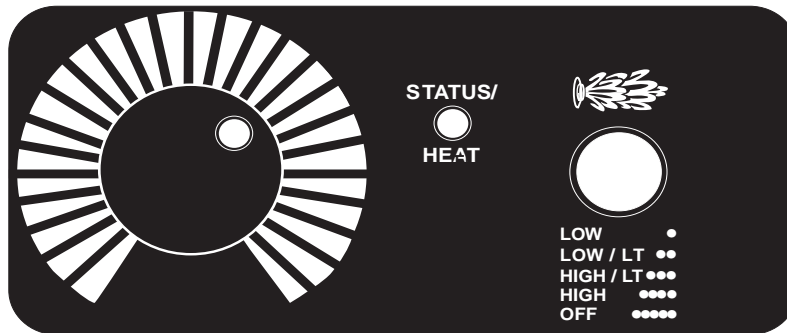

Temperature Control

To increase the temperature, turn the Temperature Control Knob clockwise to the desired setting. To reduce the temperature, turn the knob counterclockwise.

Function Control Button

Press the Function Control Button once and the low speed pump will operate. Press the button a second time and the high speed pump will operate. Press the button again and the system will turn off.

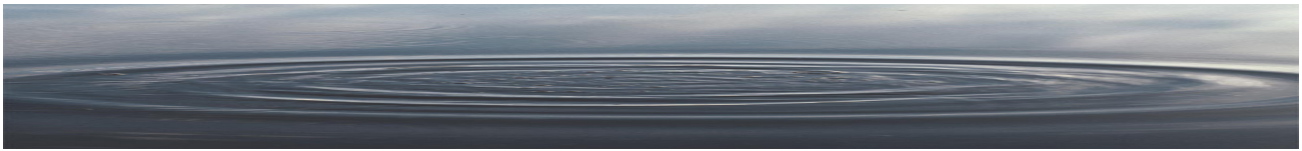

Operation

Filter Cycles

Your hot tub will automatically filter itself for 2 hours twice a day. During filtration, the low speed pump will activate. The first filter cycle will begin one minute after the hot tub has been energized. The second filter cycle will begin twelve hours after the start of the first filter cycle.

Overheat Protection

In the event the hot tub should overheat, the Status/Heat LED will flash and the hot tub will shut down. If this situation occurs, turn off all power to the hot tub and contact your dealer or service organization. To reset the hot tub, press the Function Control Button.

Flow Switch Detection

If the pressure switch malfunctions, the Status/Heat LED will flash. If this situation occurs, turn off all power to the hot tub and contact your dealer or service organization.

Open Sensor

If either the high limit or the water temperature sensors malfunction, the Status/Heat LED will flash. If this situation occurs, turn off all power to the hot tub and contact your dealer or service organization.

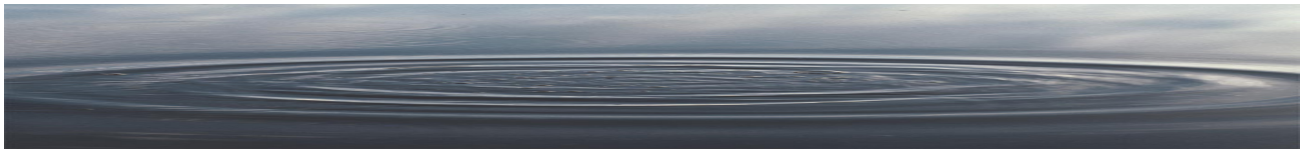

Operation

Normal Operation/Whirlpool System

You can enjoy the hot tub with or without activating the whirlpool. Either way, bathing in your hot tub can be pleasurable, as well as therapeutic. After a busy, stressful day, you can look forward to soaking in your hot tub in still water with no turbulence - only the gentle warmth of the soothing and relaxing water.

For a more invigorating hot tub experience, you can take advantage of the built-in whirlpool system. To do this, press the JETS button for one bank, or both banks of JETS. Sit or recline in the hot tub so you are comfortable. Since all of the jets are directionally adjustable, you can direct a jet toward an area where muscles feel tense and stiff. The warmth of the water and the stimulating water flow from the jets will pleasantly increase circulation.

For the total whirlpool effect and all over feeling of well being, you can adjust all jets so they point in a clockwise or counterclockwise direction to circulate the air and water mixture in a circular motion all about the hot tub.

Directionally Adjustable Whirlpool Jets



Fully Adjustable Whirlpool Jets

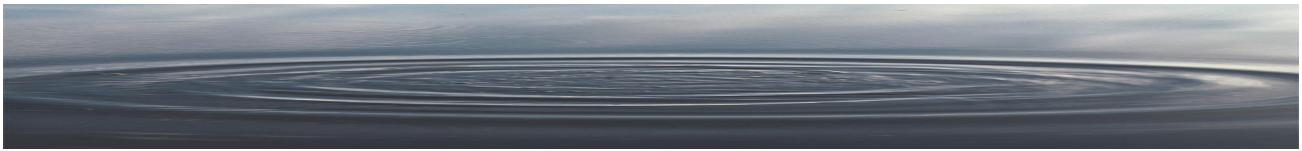

Operation

Silent Air Induction

The intensity of the whirlpool action is determined by how much air is inducted into the water. You can control this by adjusting the air induction control knobs located on the hot tub rim. For maximum air induction, rotate each control knob fully counterclockwise to the largest circle. For fewer air bubbles, decrease the amount of air induction by rotating the control knobs clockwise. When the knobs are turned to the smallest circles, only water is being circulated. (Refer to illustration below.)

Air Induction Controls

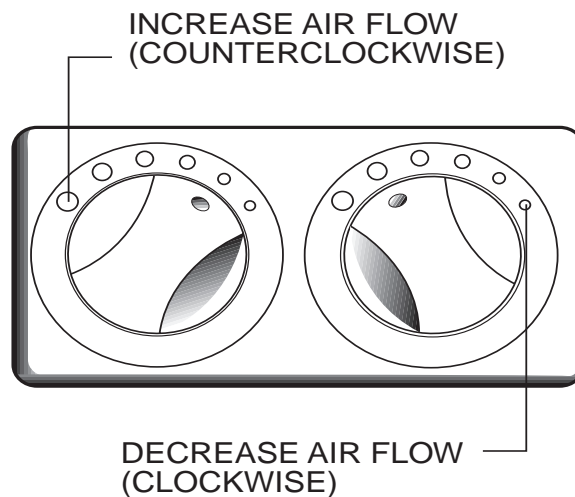

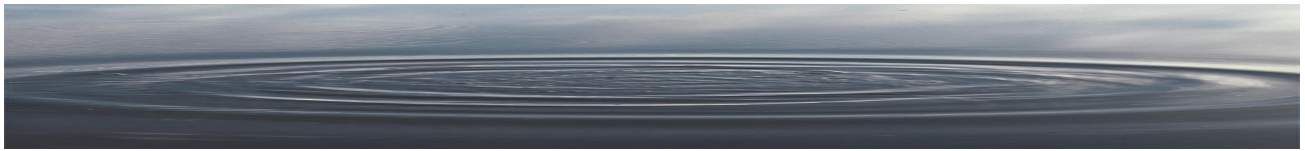

Operation

Water Rainbow

Activate the water feature by rotating downward the flow control lever located on the left side of the spout. Use this lever to adjust the amount of water flowing through the Water Rainbow spout. Turning OFF the flow at the fully adjustable jets will dramatically increase flow through the Water Rainbow and other jets.

CAUTION: The water circulating through the Water Rainbow spout is not fresh water and therefore is NOT suitable for drinking.

Water Rainbow

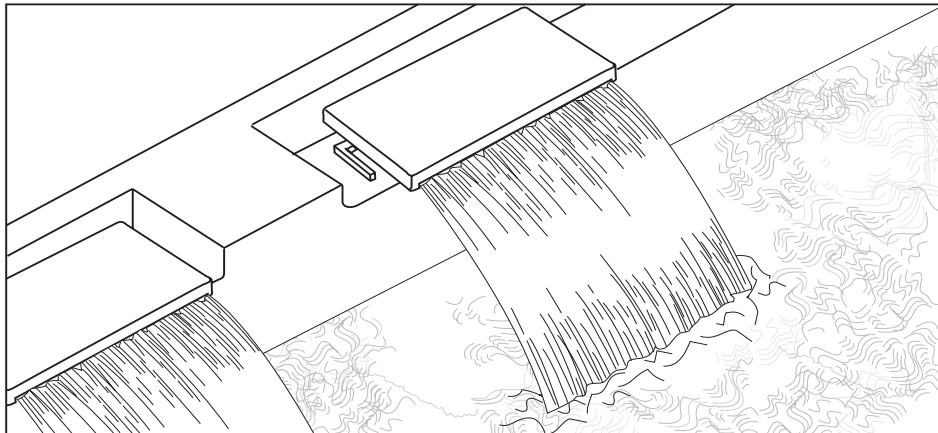

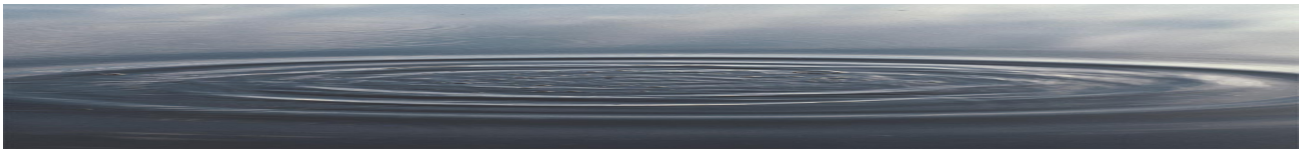

Maintenance

Water Quality and Water Chemistry

Maintaining water quality and water chemistry in your hot tub is extremely important and should be a regular part of your hot tub maintenance program, as a neglected hot tub can be a breeding place for dangerous bacteria.

The water quality of your hot tub is maintained by a combination of filtration and chemistry. The hot tub's integral filter system helps maintain the water cleanliness and clarity by trapping most solid materials such as hair and other debris resulting from normal use. However, the most important part of maintaining water chemistry is keeping the proper level of disinfectant in the water at all times. This is accomplished by adding chlorine to the water, which will control particles too small to be trapped by the filter, such as bacteria and algae, and will oxidize any organic materials. Follow the instructions provided here and with water quality products for the health and safety of hot tub users, as well as to make your hot tub bathing as enjoyable as possible.

Your Jacuzzi Premium Spas hot tub is can be equipped with an optional ozone generator which operates automatically during the system filter operation. Ozone is fed into the hot tub footwell where it mixes with the water. Ozone is used *in conjunction* with chlorine to assist in disinfecting and clarifying the water. Use of the ozone generator will generally reduce the requirement for, and the cost of, water quality maintenance chemicals.

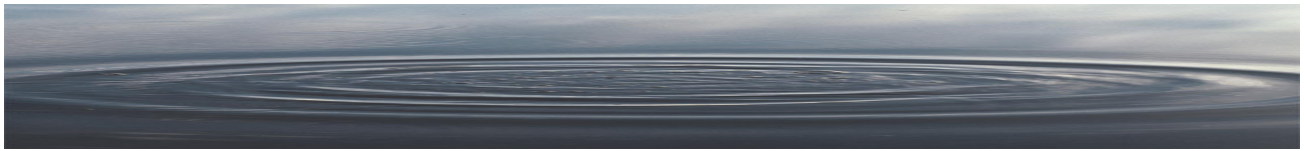

Maintenance

Filtration

The filtration system of your hot tub will keep your water clear and clean if used properly. The filter cartridge element(s) will trap most solid materials and debris in the water. However, the presence of materials such as body oils or other particles which are too small to be captured in the filter(s) may bring about various undesirable water quality conditions. These conditions can be corrected with the use of hot tub treatment chemicals which are available from your Jacuzzi Premium Spas dealer. Such conditions include the following:

Foaming: A defoamer is available to minimize foaming of the water. This condition is usually caused by the addition of soaps or oils, or other fatty substances to the hot tub water. The interaction of these with hot water, especially at high pH (more alkaline), will cause the water to foam. (Refer to Water Quality Definitions.)

Oil Film or Cloudy Water: Add water clarifier to congeal oil film on the water surface into globules sufficiently large enough to be trapped by the systems filter(s). Cloudiness is caused by particles that are too small to be trapped in the filter(s), and is also due to the presence of human body oils, lotions, and cosmetics. During normal use, these materials can accumulate on the filter element(s) and clog its pores. The addition of clarifier will make the water clearer, but clogged filters must be cleaned as prescribed under the section entitled Filter Maintenance in this manual.

Hard Water: Add a demineralizer to break down or deionize mineral particles present in the hot tub water. Follow the Filter Maintenance procedure described in this manual to ensure optimum performance of your hot tub's filtration system.

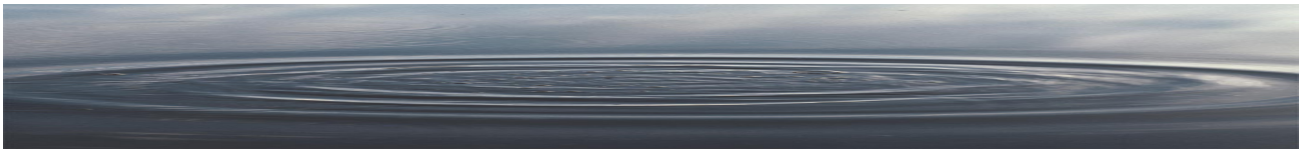

Maintenance

Water Chemistry

You can ensure better water chemistry by testing your hot tub water every day and adjusting the chemical balance frequently. Obtain a water quality test kit, designed especially for hot tubs, from your Jacuzzi Premium Spas dealer. The test kit must be of the type which allows you to test for the disinfectant (chlorine) level, pH, and total alkalinity. Ensure that the chemicals used in your hot tub are especially for hot tub use, and not for swimming pools, as water quality maintenance of hot tubs and of swimming pools is very different.

Set up a daily program at first to check the disinfectant level, pH, and total alkalinity of the water. Familiarize yourself with the amount of chemicals to add and to determine how often to make chemical adjustments during normal use. Remember that the more heavily the hot tub is used, the more often you should check the water chemistry.

When adding any chemicals, always run the filter system to ensure complete dilution with the water.

Do not add chemicals directly into the skimmer.

Disinfecting

When filling the hot tub for the first time, follow the purge/sanitizing instructions in the Equipment Set-Up procedure of the Installation Instructions.

Add chlorine to the water on a regular basis to help control the amount of bacteria, algae and organic materials. Such bacterial contaminants, if not controlled, could cause skin rashes or other physical problems. To disinfect the hot tub for normal use, first establish the amount of chlorine to add and determine how often you need to add it.

We recommend that you maintain a free chlorine level of 2.0 to 5.0 ppm at all times except when you must exceed that during the initial purge/sanitizing procedure or during superchlorination (refer to Water Quality Definitions on page 30). Superchlorinate your hot tub every two weeks with heavy use. If using sodium dichlor, add one heaping tablespoon for each 150 gallons of hot tub water. Scrub the hot tub surfaces with this solution to remove any oily deposits. This will ensure that any bacteria or algae which are resistant to the normal disinfectant level are killed. After adding the disinfectant, run the filter system and allow the free chlorine level to return to the 2.0 to 5.0 ppm range before using the hot tub again.

Do not install a cover until the disinfectant level is back to normal. High concentrations of chlorine will damage metallic plated finishes if the cover is in place.

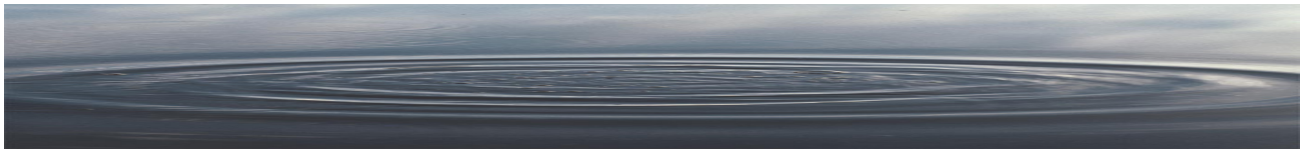

Maintenance

Balancing pH

For good hygiene and equipment longevity, maintain the pH of your hot tub water according to the instructions provided. pH is the measure to determine if the hot tub water is too acidic (low pH) or too alkaline (high pH). The ideal range for hot tub water is 7.4 to 7.6 pH. For excessive acidity (below 7.2 pH) add soda ash or sodium bicarbonate to the hot tub water. For excessive alkalinity (above 7.5 pH) add dry acid to the spa water.

CAUTION: Refer to the hot tub chemical manufacturer's instructions for the initial amount of chemicals to add for the gallonage of your hot tub. Low pH can cause equipment damage, as acidic water will dissolve metals, while high pH can cause scale or calcium deposits to build up in the system or on the shell. After adding chemicals, run the filter system for at least 30 minutes before testing water quality again for accurate readings.

Balancing Total Alkalinity

Total alkalinity is the measure of base materials in the water. The recommended range for total alkalinity is between 80 ppm and 150 ppm. If the chemistry of the water is not within this range, you will have difficulty adjusting your pH level, which will affect your adjustments for the proper amount of free available chlorine. If the alkalinity of your hot tub water is high, it is advisable to drain the water from the hot tub, refill and begin the balancing process over again. Purge and sanitize your hot tub (according to the instructions in the Equipment Set-Up section of the Installation Instructions) and clean the hot tub surfaces thoroughly before refilling with fresh water. Then reestablish water chemistry. If the hot tub is used heavily, change the water at least every month.

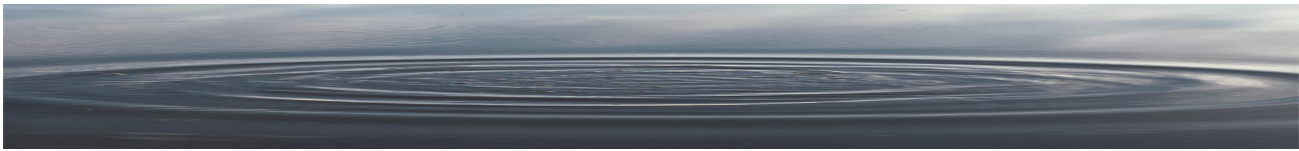

Maintenance

Water Quality Definitions

pH: A chemical term used in expressing relative acidity or alkalinity in numerical values with 7.0 usually regarded as neutral, and for purposes of this manual, indicating pure water. From 7 to 0 indicates increasing acidity, and 7 to 14 indicates alkalinity.

PPM: Parts per million

Ozone: Triatomic oxygen (O_3), a gas found commonly in nature, which, when dissolved in hot tub water helps destroy impurities and contaminants.

Free Chlorine: Chlorine that has not combined with other chemicals and that is available to destroy bacteria in the hot tub water.

Trichlor: A form of chlorine used in pool water treatment; usually supplied in tablet form. Not recommended because of its higher acidic nature and slow dissolving action. Prolonged contact with the hot tub shell may bleach or permanently mark the shell.

Sodium Dichlor: The type of chlorine that is recommended for hot tub use, as it is available in fast dissolving granular form. It is neither excessively acidic nor alkaline in character and does not readily dissipate in higher water temperatures.

Calcium Hypochlorite: A granular chlorine product that is inexpensive and effective but not recommended because it often tends to form calcium deposits on heater parts and plumbing fittings and leaves an unattractive film on the hot tub at the water line.

Sodium Hypochlorite: A liquid chlorine product that is inexpensive and effective but not recommended because the liquid is readily spilled onto the hot tub or a surrounding area, causing permanent damage.

Total Alkalinity: The measure of alkaline materials (such as carbonates, bicarbonates and hydroxides) in the water. High alkalinity inhibits the effectiveness of chemicals to change the pH. If the alkalinity of your hot tub water is high (above 150 ppm), it is advisable to drain the water from your hot tub, refill and begin the balancing process over again. Low alkalinity (below 60 ppm) could be corrosive and damage your hot tub system.

Superchlorination: (Also referred to as shock treatment.) the addition of an above-normal level of disinfectant to kill any bacteria or algae that might have become resistant to normal levels of disinfectant.

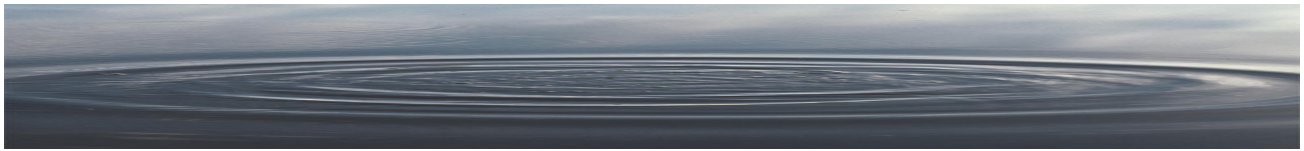

Maintenance

Water Level/Drain

The water level in the hot tub must be maintained at the normal level. Evaporation and splashing will cause the water level to drop.

When concentrations of impurities from evaporation, water quality chemicals, body oils, perfumes, dirty feet, and winds, etc., accumulate in the hot tub and cannot be filtered out, it is necessary to drain your hot tub and refill it with fresh water. This should be done every two months or more often depending on the amount of usage.

To drain the hot tub, turn **OFF** the circuit breakers at the main electrical panel. Connect a garden hose to the drain valve. Open the valve and drain the hot tub.

After draining the hot tub, clean the hot tub shell, suction cover, skimmer, and filter(s). Close the drain valve. Then refill the hot tub with fresh water. Check the pH level and maintain water quality.

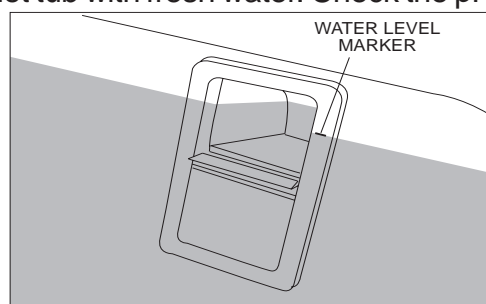

The suction cover located in the footwell area should be checked at least once a week for collected debris, such as leaves, hair, etc., and cleaned as necessary. It may not be necessary to remove the suction cover to clean it, but if you need to, remove the center screw with a Phillips screwdriver and clean the cover by flushing with water from a hose.

CAUTION: Ensure replacement of the suction cover immediately after cleaning. It is a safety device and must be in place over the suction fitting to minimize the potential hazard of hair and body entrapment.

If heavy rains raise the hot tub water level, drain the hot tub to its normal level.

A hot tub cover (available as an option), when in place over the hot tub, will help reduce evaporation and control the amount of debris entering the hot tub when the hot tub is not occupied. In addition, its use will reduce energy consumption.

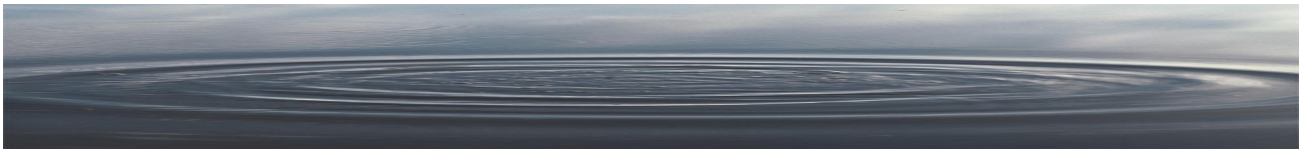

Maintenance

Skimmer Basket Maintenance

The basket located in the skimmer of the hot tub should be checked at least once a week for collection of debris, such as leaves, hair, etc., and cleaned as necessary. To clean the basket, remove it from the skimmer by pulling it out, then backflush it with water from a garden hose and reinstall.

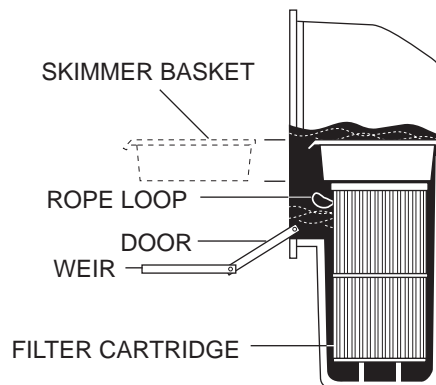

Filter Maintenance

The filter cartridge(s) should be checked periodically. In normal use, check them at least once a month. Keep them clean. An obstructed filter cartridge reduces water quality and inhibits proper system performance.

Removable filter cartridges are located inside the filter well. To remove them, lift the well cover, then pull the filter cartridges upward and out of the well by the loop at the top of the filters. Clean the filter by separating the folds of the filter and spraying with fresh water from a garden hose. Then reinstall the cartridges into the well reversing the above procedure. See Equipment Set-Up.

Oils will coat the filter, resulting in a reduced flow. To remove such materials, soak the cartridge in a plastic pail containing a commercial filter cleaning solution (available from your Jacuzzi Premium Spas dealer or most pool supply stores). Follow the manufacturer's instructions for use. Another method is to soak the filter in a plastic pail containing a mild solution of trisodium phosphate (TSP) and water. An hour of soaking time is usually required to break down oil coatings from the cartridge. Use a stronger solution of TSP and water to remove algae. Most hardware or paint stores stock TSP. Use the same method of cleaning when the cartridge becomes plugged with clay or vegetation. Replacement cartridges are available through your Jacuzzi Premium Spas dealer.

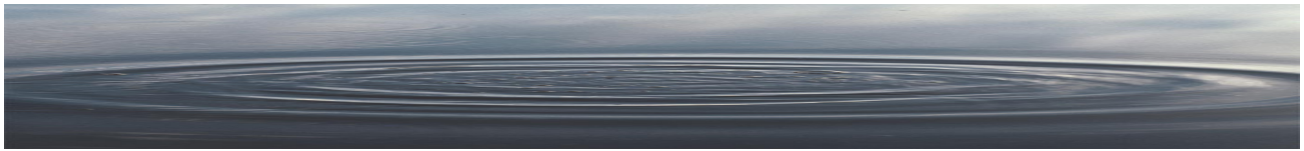

Maintenance

Factory Installed Wood Skirt

Your hot tub is supplied with a factory-installed wood skirt which completely surrounds the hot tub. The skirt can be opened for service.

If it becomes necessary to remove one or more of the skirt panels for service access, simply remove all the screws from the panel being detached.

The panels can be reattached to the hot tub by reversing the above procedure.

NOTE: When you remove the skirt, you will notice the plastic covered insulating batts. These batts are designed to be removed when service is required and reinstalled when service has been completed.

Automatic Filtration/Maintenance

If you plan to be away, minimum water quality will be maintained by running the filter system.

If you will be away for an extended period, however, we recommend that you drain the hot tub (following the procedure described under Winterizing on this page), as long periods without maintenance of water quality could be detrimental to the hot tub.

Another means of maintaining minimum water quality while away for less than two weeks is to follow the procedure outlined for winterizing your hot tub in a warm climate. (Refer to Winterizing.)

NOTE: We do not recommend using this procedure if you are absent during the summer, when algae build-up is most likely.

Always keep your hot tub covered when not in use to reduce heat loss and evaporation and to prevent debris from falling in.

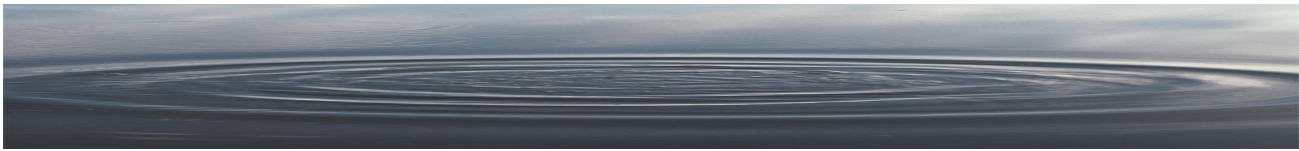

Maintenance

Winterizing

In a climate where winter temperatures are below freezing, follow this procedure when the hot tub will NOT be used:

1. Turn OFF the power to the unit at the main electrical panel.
2. Drain the hot tub completely by attaching a garden hose to the drain valve. Then remove the hose and leave the drain valve open to drain the hot tub of any residual water. After the hot tub has drained, turn the circuit breaker on and turn the blower on briefly. NOTE: Stand back to avoid any spray. Turn the circuit breaker off. This will evacuate any residual water from the air injector lines. Remove any remaining water in the seating areas and footwell.
3. Open all pump/motor unions as shown below. Remove the spring clamp, disconnect the hose from the barbed fitting and drain. After draining, close the union hand tight and reinstall circulating pump hose and clamp. Remove any residual water from the pan. When refilling the hot tub, check for leaks.

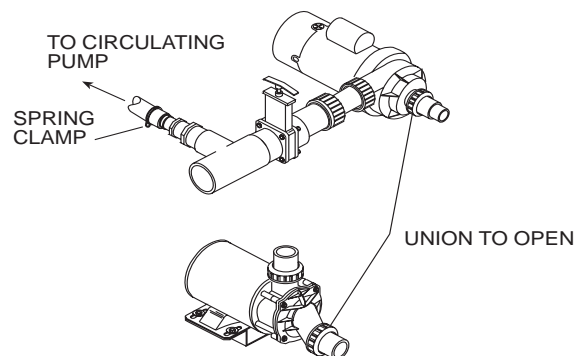

4. Remove, clean and store the filter cartridge(s) in a dry location.
5. Keep water and debris out by covering with a hot tub cover.

Before using the hot tub again, review the Operating Instructions.

In a warm climate where there are occasional freezing temperatures, your hot tub is automatically protected against freezing. Whenever the water temperature falls to 40°F, the pumps will activate to circulate water until the temperature reaches 45°F.

To maintain water quality, adjust the temperature setpoint to the minimum setting (80°F).

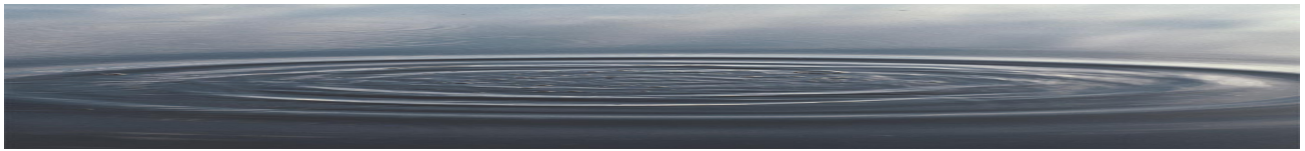

Maintenance

Hot Tub Light (except Alexa)

Two filters, one blue and one red, are provided with each hot tub light. To change the filter, simply snap the colored filters in place on top of the normal lens. Two replacement bulbs are also included. Put them in a safe place for future use. When a bulb burns out, replace it from the **back** of the light fitting on the rear surface of the shell by pulling out the bulb receptacle.

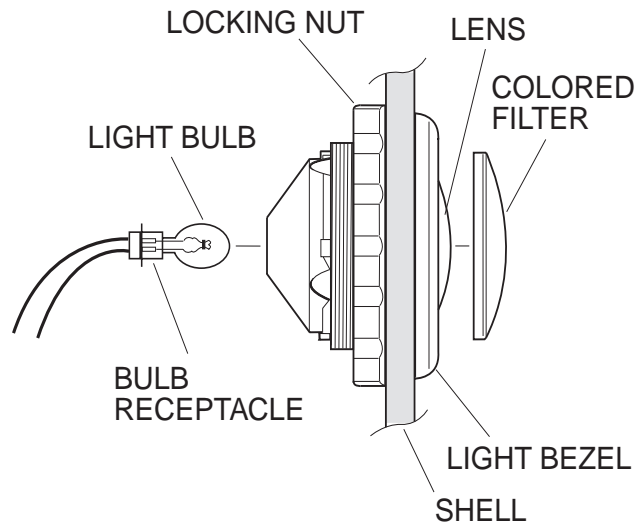

Light Bulb Replacement

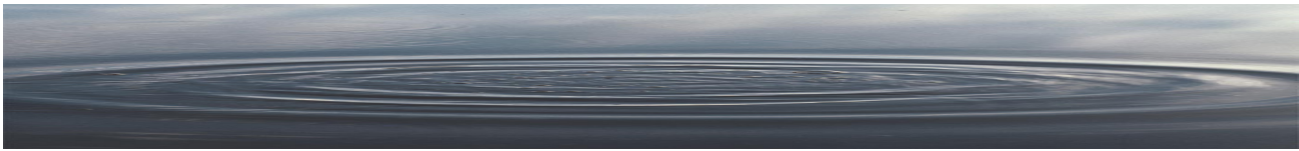

Maintenance

Cleaning Your Hot Tub

Your hot tub shell consists of two layers of plastic materials. Its smooth surface of acrylic is tough and durable and contains concentrated color. This is supported by a substantial thickness of fiberglass-reinforced polyester resin. A catalyst causes a chemical reaction during manufacture that bonds these layers permanently into a hard, strong material. With a minimum amount of care and cleaning, your hot tub will look new for years.

To clean your hot tub, simply use a mild, nonabrasive liquid detergent, isopropyl alcohol, or a commercially prepared hot tub cleaner. **Do not use abrasive cleaners.** You can protect and restore the gloss to a dulled surface by applying Mequiar's #10 Mirror Glaze, which is a product specifically designed for use on acrylic finishes. If Mequiar's is not available, an acrylic polish of equal quality or automotive paste wax will do.

Use a hot tub cleaner for residue build-up at the water level of the hot tub surface. This may be applied to the acrylic surface with a soft cloth and wiped clean. Use sparingly in small amounts to avoid contaminating the hot tub water. If the water line is heavily soiled, it may be advisable to lower the water level 2-3 inches before cleaning; then refill to the normal level.

Covering Your Hot Tub

An optional hot tub cover for your hot tub is available from your Jacuzzi Premium Spas dealer. Use of this cover will help reduce energy costs by minimizing heat loss and evaporation. In addition, the attractive cover is an effective means of preventing debris such as leaves and dirt from entering your hot tub when not in use. Follow the instructions for use and care provided with the hot tub cover.

CAUTION: The hot tub cover is not designed to support any weight. Therefore, as a safety precaution and to preserve the life of your cover, you must not sit, stand, or lie on it; nor should you place objects of any kind on top of it.

NOTE: Jacuzzi Premium Spas does not guarantee or warrant this cover. Refer to the hot tub cover manufacturer's information provided with the cover.

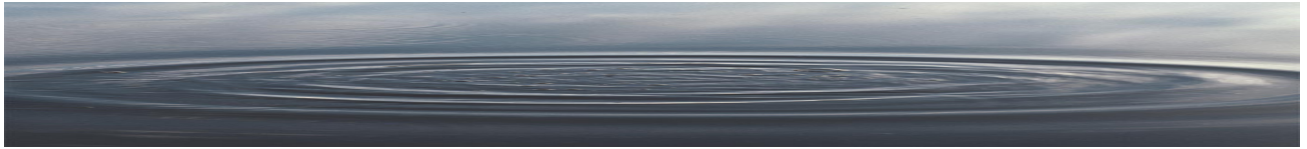

Maintenance

Repairs to the Acrylic

Minor scratches which do not penetrate the color finish (acrylic) can be removed with 600-grit wet/dry sandpaper. Restore the glossy finish with Meguiar's #10 Mirror Glaze or comparable automotive paste wax.

Major scratches or gouges which penetrate the acrylic surface will require refinishing. Ask your Jacuzzi Premium Spas dealer for special instructions.

Headrest Pillows

Clean the pillows regularly with soap and water and a clean cloth. Use a vinyl conditioner once a month to maintain the water resistance and lustrous finish. The pillows are held in place by snap-in fittings and can easily be removed for cleaning. For all units, remove the pillows if a chlorine shock treatment is used.

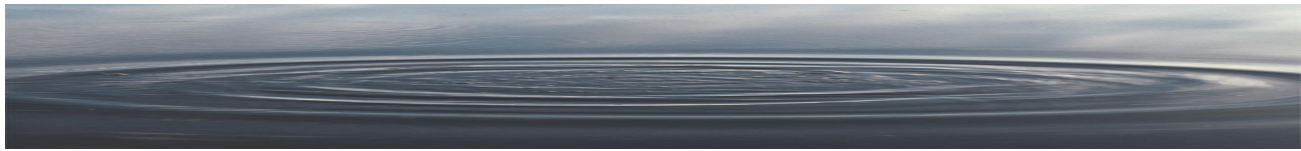

Troubleshooting

***NOTE: See also DISPLAY MESSAGES.**

Problem	Probable Cause	Remedy
1. Water not clean.	<ul style="list-style-type: none"> A. Clogged or blocked suction cover or skimmer basket. B. Filter clogged (dirty). C. Poor water chemistry. D. Improper maintenance. E. High content of solids in water. F. Filter motor plug not connected to the electrical cabinet. 	<ul style="list-style-type: none"> A. Clean suction/skimmer B. Clean or replace filter. C. See Chemistry section. D. See Maintenance section. E. Use clarifier or drain and refill the hot tub. F. Check filter motor connection on the electrical cabinet.
2. Abnormal water usage.	<ul style="list-style-type: none"> A. Leak in suction line, discharge line, or connections. B. Excessive evaporation and/or splashing. 	<ul style="list-style-type: none"> A. Repair leak. B. Use rigid hot tub cover; lower thermostat setting.
3. Low water flow from jets.	<ul style="list-style-type: none"> A. Low water level. B. Clogged or blocked suction cover, or skimmer basket. C. Dirty filter. D. Adjustable jet partially closed. E. Suction or discharge line partially plugged. F. Pump running at subnormal speed. G. Worn or damaged pump seal. H. Subnormal voltage. 	<ul style="list-style-type: none"> A. Fill to water level indicator mark on skimmer/filter frame. B. Clean suction or skimmer basket. C. Clean or replace filter. D. Open jet. E. * F. * G. * H. Call a qualified electrician or your power company.

***NOTE:** The skills and tools necessary for the safe repair of this hot tub require the services of qualified personnel. **Contact** your Jacuzzi Premium Spas dealer or service organization.

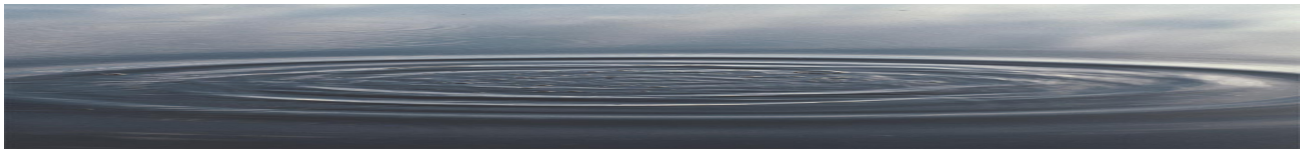

Troubleshooting

Problem	Probable Cause	Remedy
4. No water flow from jets.	<ul style="list-style-type: none"> A. Power turned OFF. B. Pump OFF. C. Motor(s) not connected. D. House circuit breaker tripped; no power to system. E. GFCI tripped. F. Faulty pump or motor. 	<ul style="list-style-type: none"> A. Turn ON power at the service panel. B. Press jets button. C. Check motor plug connections on electrical cabinet. D. Reset circuit breaker. E. Reset GFCI. F. *
5. Noisy pump and motor.	<ul style="list-style-type: none"> A. Clogged suction cover(s). B. Leakage of air into suction line. C. Vibrating parts attached to motor or support brackets. D. Low water level. E. Damaged or worn motor bearings. F. Impeller rubbing inside case. G. Debris inside pump. 	<ul style="list-style-type: none"> A. Clean suction cover(s). B. Locate and repair leaks. C. Tighten fasteners. D. Add water to normal level. E. * F. * G. *
6. Water leakage at pump shaft (rotating connection between pump and motor).	<ul style="list-style-type: none"> A. Worn or damaged pump seal. 	<ul style="list-style-type: none"> A. *
7. Motor will not start.	<ul style="list-style-type: none"> A. Power OFF. B. House circuit breaker tripped or in OFF position. C. GFCI tripped. D. Subnormal voltage. E. Improper or defective wiring. F. Locked shaft or impeller. G. Motor windings burned out. H. Defective starting switch inside motor. 	<ul style="list-style-type: none"> A. Turn ON power at the service panel. B. Reset circuit breaker. C. Reset GFCI. Call a qualified electrician or your power company. E. * F. * G. * H. *

***NOTE:** The skills and tools necessary for the safe repair of this hot tub require the services of qualified personnel. **Contact** your Jacuzzi Premium Spas dealer or service organization.

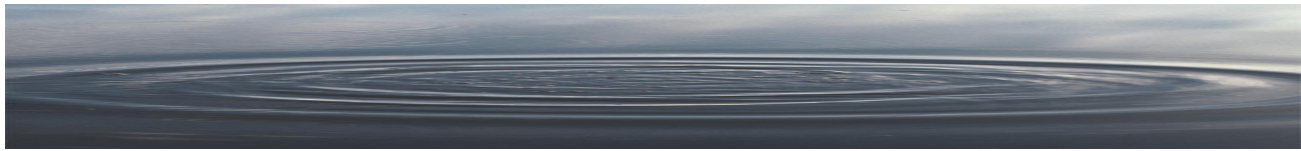

Troubleshooting

Problem	Probable Cause	Remedy
8. Motor stops.	A. Motor overload condition. B. Inadequate supply wiring.	A. Let cool for one hour. Motor overload will reset; if problem persists, see *NOTE. B. Consult a qualified electrician to correct wiring to unit.
9. Air blower does not operate.	A. Power OFF. B. Switch is OFF. C. House breaker tripped, no power to system. D. GFCI tripped. E. Faulty motor.	A. Turn power ON at the service panel. B. Press blower button. C. Reset circuit breaker. D. Reset GFCI. E. *

***NOTE:** The skills and tools necessary for the safe repair of this hot tub require the services of qualified personnel. **Contact** your Jacuzzi Premium Spas dealer or service organization.

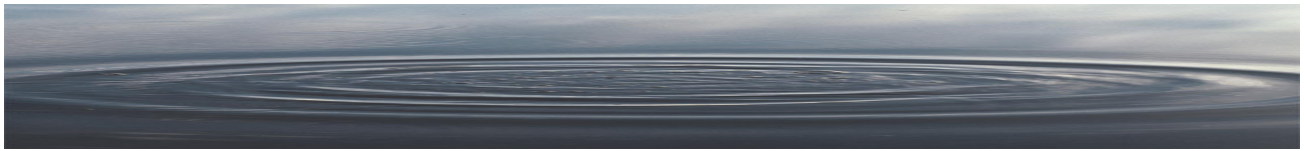

Alternate Use of the Water Rainbow as a Fill Spout

You can use your Water Rainbow as a fill spout by permanently plumbing it to a fresh water supply if local codes permit. Local plumbing codes may require the use of an anti-siphon valve for such a connection. **Do not interconnect water supply with recirculating system of the hot tub.**

To make the connections necessary to use the Water Rainbow as a fill spout, follow this procedure:

- Turn **OFF** circuit breakers at the main electrical panel and drain the hot tub completely.
- Unscrew the spout from the 3/4" pipe.
- Cut the 3/4" piping as shown in the illustration below.
- Cap the piping by cementing a 3/4" PVC cap where the cut has been made.
- Connect permanent plumbing line to the spout.

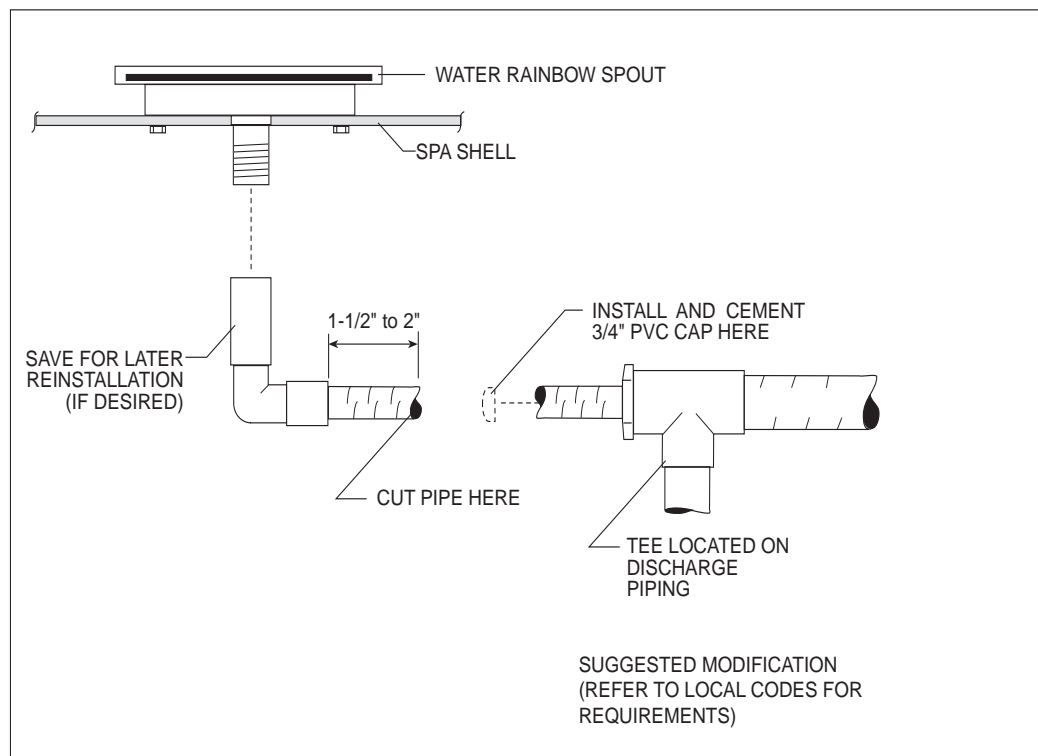

**Product specifications are subject to change without notice.
Use installation instructions supplied with this product.**

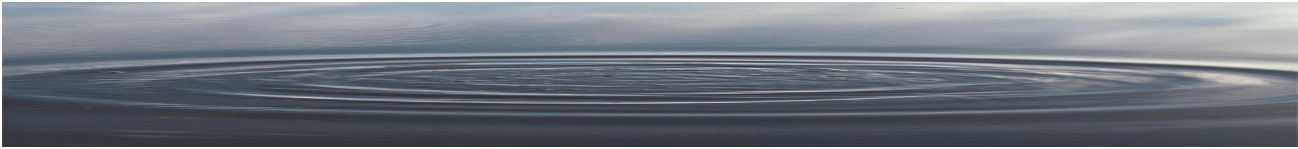

Notes

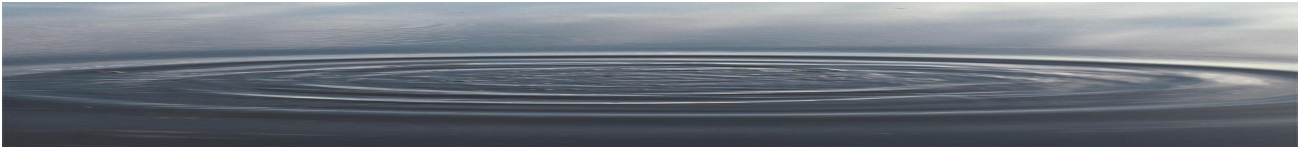

Notes

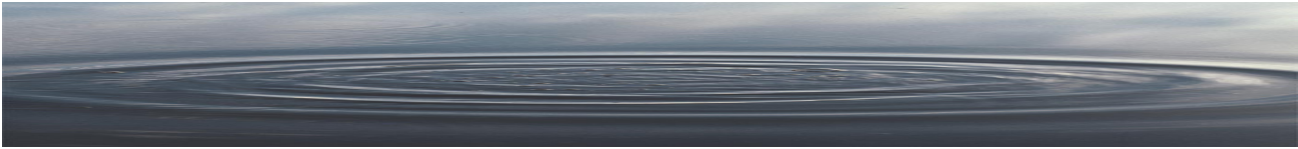

Notes



14525 Monte Vista Avenue, CA 91710
Part #2530-301 - REV. A - 2001 Jacuzzi Premium Spas